

DEVELON

Mini Excavator

DX55R-7



Engine

Make	DEVELON
Model	D18
Number of cylinders	3
Rated power, gross (hp per SAE J1995)	48.8 hp (36.4 kW) @ 2200 rpm
Rated power, net (hp per SAE J1349)	47 hp (35.1 kW) @ 2200 rpm
Max. torque, net (SAE J1995)	133 lbf.-ft. (18.4 kgf.m) @ 1600 rpm
Displacement	146 in. ³ (2.4 L)
Bore and stroke	3.5 in. x 3.7 in. (90 mm x 94 mm)
Starter	12 V, 3.6 hp (2.7 kW)
Battery	12 V, 100 AH
Alternator	12 V, 90 amp
Air cleaner	Double elements

Hydraulics

Main pumps	1 x 37 gpm (139 L/min.)
Pilot pump (gear design)	-
Relief pressure	4496 psi (316 kg/cm ²)

Maximum System Pressure

Boom/arm/bucket (normal mode)	3989 psi (280 kg/cm ²)
Swing (crossover relief)	3129 psi (220 kg/cm ²)

Undercarriage

Upper rollers (each track)	1
Lower rollers (each track)	4
Number of shoes (links per side)	Single assembly (rubber)

Swing Mechanism

Swing speed	9.8 rpm
Swing torque	9982 lbf.-ft. (1380 kgf.m)

Drive System

Travel speed (low – high)	1.62 – 2.73 mph (2.6 – 4.4 km/h)
Traction force, max. (drawbar pull)	10097 lbf. (4580 kgf)
Max. grade	70% (35°)

Environment

Sound level (ISO 6395)	97 dB(A)
Cabin sound level (ISO 6396)	78 dB(A)

Refill Capacities

Fuel tank	20.61 gal. (78 L)
Cooling system (radiator capacity)	2.85 gal. (10.8 L)
Engine oil	2.43 gal. (9.2 L)
Final drive (each side)	0.3 gal. (1 L)
Hydraulic system	27.74 gal. (105 L)
Hydraulic tank	12.7 gal. (48 L)

Hydraulic Cylinders

Boom ¹ (1) bore x rod diameter x stroke	3.7 in. x 26.7 in. x 2.2 in. (95 mm x 678 mm x 55 mm)
Arm ^{1,2} (1) bore x rod diameter x stroke	3.1 in. x 28.6 in. x 2.2 in. (80 mm x 726 mm x 55 mm)
Bucket ¹ (1) bore x rod diameter x stroke	2.8 in. x 23.6 in. x 1.8 in. (70 mm x 600 mm x 45 mm)
Swing – boom ¹ (1) bore x rod diameter x stroke	3.7 in. x 17.7 in. x 2.4 in. (95 mm x 449 mm x 60 mm)
Blade ¹ (2) bore x rod diameter x stroke	4.3 in. x 7.8 in. x 2.4 in. (110 mm x 197 mm x 60 mm)

¹ Cushion on rod end

² Cushion on base end

The piston rods and cylinder bodies are made of high-strength steel. A shock-absorbing mechanism is fitted in all cylinders to ensure shock-free operation and extended piston life.

Dimensions

		Standard Arm Cabin & Canopy (US20/US30)	Long Arm Cabin & Canopy (US21/US31)
Boom type		8' 10" (2700 mm)	
Arm type		5' 3" (1600 mm)	6' 3" (1900 mm)
Bucket type (SAE)		5.7 ft. ³ (0.16 m ³)	
Track type		Fixed (rubber)	
Shipping length	A	17' 10" (5445 mm)	
Overall height	B	8' 4" (2560 mm)	
Shipping width	C	6' 5" (1980 mm)	
Tail swing radius	D	3' 5" (1050 mm)	
Tail swing overhang (rear)*		-	
Tail swing overhang (side)	E	2.4" (60 mm)	
Counterweight clearance	F	2' 1" (628 mm)	
Upper structure width	H	5' 9" (1750 mm)	
Cabin height above house	I	3' 3" (987 mm)	
Tumbler distance	J	6' 6" (1990 mm)	
Overall track length	K	8' 2" (2497 mm)	
Undercarriage width	L	6' 6" (1980 mm)	
Track gauge	M	5' 2" (1580 mm)	
Track width	N	1' 4" (400 mm)	
Track height	O	1' 10" (562 mm)	
Car body clearance	P	2' 1" (628 mm)	
Blade height	Q	1' 2" (349 mm)	
Blade clearance	R	1' 7" (470 mm)	
Max. blade cut, below ground	S	1' 6" (450 mm)	

*Not shown on diagram
Less than zero indicated as "-"

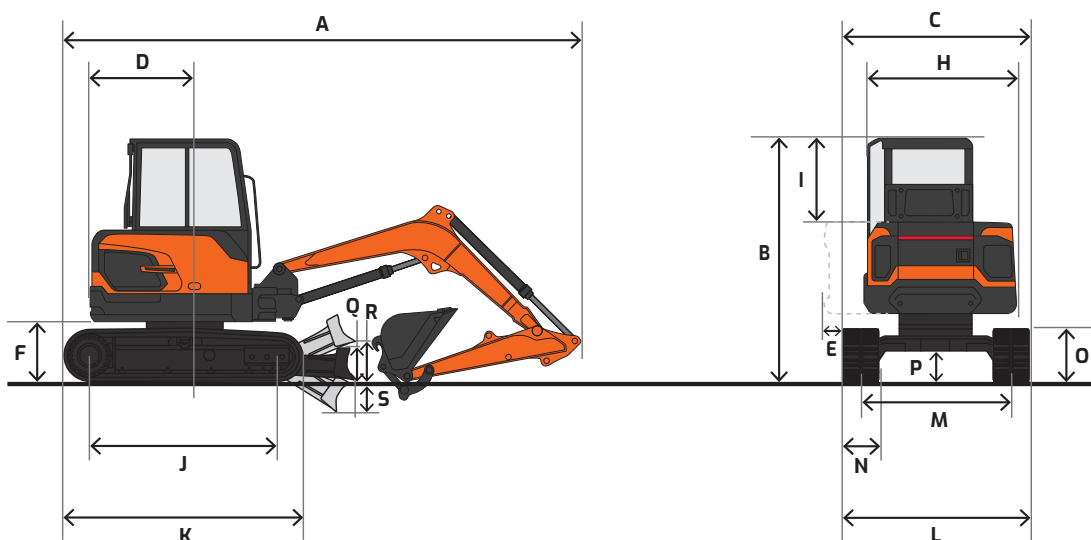

Working Range

		Standard Arm Cabin & Canopy (US20/US30)	Long Arm Cabin & Canopy (US21/US31)
Boom length		8' 10" (2700 mm)	
Arm length		5' 3" (1600 mm)	6' 3" (1900 mm)
Bucket capacity (SAE)		5.7 ft. ³ (0.16 m ³)	
Max. digging reach	A	20' 0" (6090 mm)	
Max. digging reach (ground)	B	19' 6" (5950 mm)	
Max. digging depth	C	11' 11" (3630 mm)	
Max. dumping height	D	12' 11" (3925 mm)	
Max. digging height	E	18' 8" (5680 mm)	
Max. bucket pin height	F	15' 10" (4815 mm)	
Max. vertical wall depth	G	10' 9" (3285 mm)	
Max. vertical digging radius	H	11' 3" (3430 mm)	
Min. swing radius	I	8' 4" (2550 mm)	
Boom swing – left/right		60° / 53°	
Digging force, bucket (PCSA)		9766 lbf. (4430 kgf)	
Digging force, arm		6151 lbf. (2790 kgf)	5445.4 lbf. (2470 kgf)
Counterweight		1213 lb. (550 kg)	
Operating weight		12655 lb. (5740 kg)	
Ground pressure		4.7 psi (0.33 kgf/cm ²)	

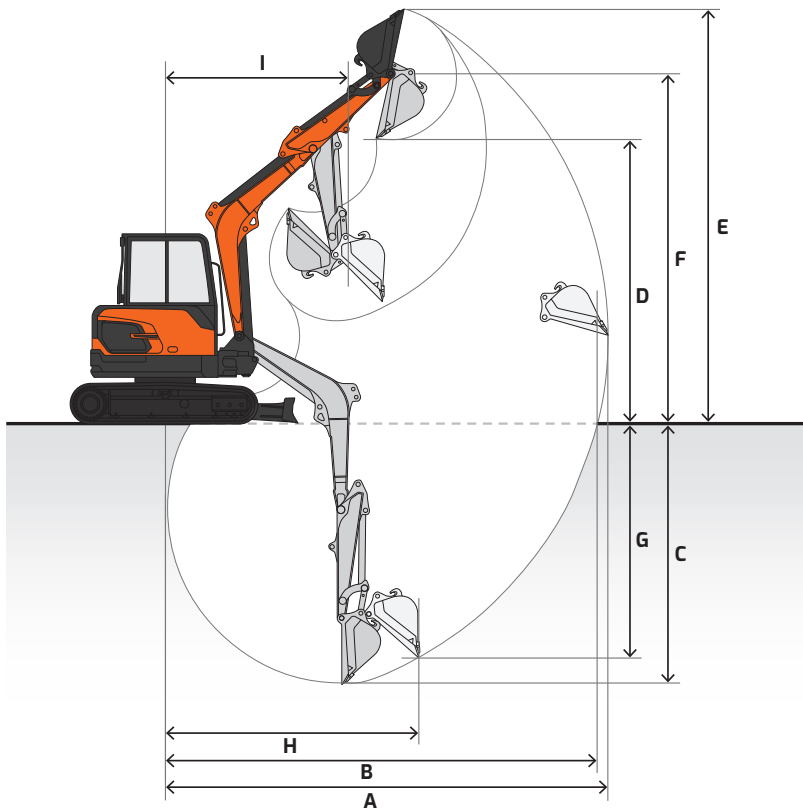

Bucket

	Standard Arm & HVAC Cabin (US20)	Long Arm & HVAC Cabin (US21)	Standard Arm & Canopy (US30)	Long Arm & Canopy (US31)
Boom	8' 10" (2700 mm)			
Arm	5' 3" (1600 mm)	6' 3" (1900 mm)	5' 3" (1600 mm)	6' 3" (1900 mm)
Shoe size	1' 4" (400 mm)			
Track type	Fixed (rubber)			

Bucket Type	Model	Capacity* yd ³ (m ³)	Width in. (mm)	Weight lb. (kg)	Height in. (mm)	Length in. (mm)	Number of teeth	Connection/ Type
Quick hitch Ditching (QH05GB)	DC05GB-36QH	0.29 (0.22)	36 (914.4)	290 (131.5)	21.1667 (534.9)	14.75 (1060.4)	-	Quick hitch 1.25"
	DC05GB-42QH	0.35 (0.26)	42 (1066.8)	325 (147.4)		26.25 (666.7)		
	DC05GB-48GH	0.4 (0.3)	48 (2133.6)	365 (165.5)				
Quick hitch Heavy-Duty (QH05GB)	HD05GB-12QH	0.08 (0.06)	12 (304.8)	140 (63.5)	21.1875 (538.1)	33.875 (860.4)	3	Quick hitch 1.25"
	HD05GB-18QH	0.13 (0.09)	18 (457.2)	180 (81.6)			4	
	HD05GB-24QH	0.18 (0.14)	24 (609.6)	220 (99.7)			5	
	HD05GB-30QH	0.24 (0.18)	30 (762)	250 (113.4)			5	
	HD06GB-36QH	0.3 (0.23)	36 (914.4)	290 (131.5)			6	
Pin-on Ditching	DC05GB-36	0.3 (0.23)	37 (1854.2)	355 (161)	27 (685.8)	30 (762)	-	Pin-on
	DC05GB-42	0.36 (0.27)	43 (1092.2)	390 (176.9)				
	DC05GB-48	0.42 (0.32)	49 (1244.6)	425 (193.2)				
	DC05GB-54	0.47 (0.36)	55 (1397)	470 (213.2)				
	DC05GB-60	0.53 (0.40)	61 (1549.4)	510 (231.3)				
Pin-on Heavy-Duty	HD05GB-12	0.1 (0.07)	12.375 (314.3)	210 (95.2)	26 (660.4)	37.25 (933.4)	3	Pin-on
	HD05GB-16	0.12 (0.09)	17 (431.8)	245 (111.1)			4	
	HD05GB-18	0.14 (0.10)	19 (482.6)	250 (113.4)			4	
	HD05GB-24	0.2 (0.15)	25 (635)	290 (131.5)			5	
	HD05GB-30	0.24 (0.18)	31 (787.4)	315 (142.9)			5	
	HD05GB-36	0.32 (0.24)	37 (1854.2)	375 (170)			6	

*Capacity based on ISO 7451 and heaped with a 1:1 angle of repose

· Equipped with bolt-on wear shrouds

· Equipped with bolt-on teeth

· Equipped with bolt-on cutting edge

· These recommendations are given as a guide only and based on typical operating conditions.



















Please consult with your DEVELON dealer to properly match buckets and attachments for the application.

Lifting Capacity

 Rating over front  Rating over side or 360°

DX55R-7 US20/US30

Boom: 8' 10" (2700 mm) | Arm: 5' 3" (1600 mm) | Counterweight: 1213 lb. (550 kg) | Bucket: None | Unit lb. (kg)

A (ft. or m) B (ft. or m)	3' 3" (1.0 m)			6' 7" (2.0 m)			9' 10" (3.0 m)			13' 1" (4.0 m)			16' 5" (5.0 m)			Max. Reach			
	 †			 †			 †			 †			 †			 †			A
13' 1" (4.0 m)										* 2560 (* 1160)	2380 (1080)	2160 (980)				* 2270 (* 1030)	2230 (1010)	2030 (920)	13' 7" (4130 m)
9' 10" (3.0 m)										* 2490 (* 1130)	2380 (1080)	2160 (980)				* 2050 (* 930)	1720 (780)	1570 (710)	15' 9" (4800 m)
6' 7" (2.0 m)							* 3730 (* 1690)	3640 (1650)	3260 (1480)	* 2980 (* 1350)	2290 (1040)	2070 (940)	* 2710 (* 1230)	1590 (720)	1460 (660)	* 2010 (* 910)	1520 (690)	1390 (630)	16' 10" (5120 m)
3' 3" (1.0 m)							* 5380 (* 2440)	3370 (1530)	3000 (1360)	* 3590 (* 1630)	2180 (990)	1960 (890)	* 2910 (* 1320)	1540 (700)	1410 (640)	* 2120 (* 960)	1460 (660)	1320 (600)	17' 1" (5200 m)
Ground Level							* 6130 (* 2780)	3220 (1460)	2870 (1300)	* 4010 (* 1820)	2090 (950)	1900 (860)	* 2890 (* 1310)	1520 (690)	1390 (630)	* 2380 (* 1080)	1500 (680)	1370 (620)	16' 6" (5030 m)
-3' 3" (-1.0 m)	* 5890 (* 2670)	* 5890 (* 2670)	* 5890 (* 2670)	* 7650 (* 3470)	6640 (3010)	5620 (2550)	* 5950 (* 2700)	3200 (1450)	2840 (1290)	* 3920 (* 1780)	2070 (940)	1870 (850)				* 3000 (* 1360)	1720 (780)	1570 (710)	15' 1" (4590 m)
-6' 7" (-2.0 m)				* 8070 (* 3660)	6790 (3080)	5750 (2610)	* 4720 (* 2140)	3260 (1480)	2910 (1320)							* 3130 (* 1420)	2360 (1070)	2140 (970)	12' 3" (3730 m)

A Distance from center of rotation † Dozer blade in down position
B Height

NOTE: Lifting capacities are in compliance with SAE 1097 and ISO 10567. Machine in lifting mode with power boost turned on. Load point is the end of the arm. Rated loads shown do not exceed 75% of minimum tipping loads or 87% of hydraulic capacities. Rated loads marked with an asterisk (*) are limited by hydraulic capacities. The least stable position is over the side. The total mass of machine includes the mass of the boom, arm, counterweight, all operating fluids and 165 lb. (75 kg) operator.

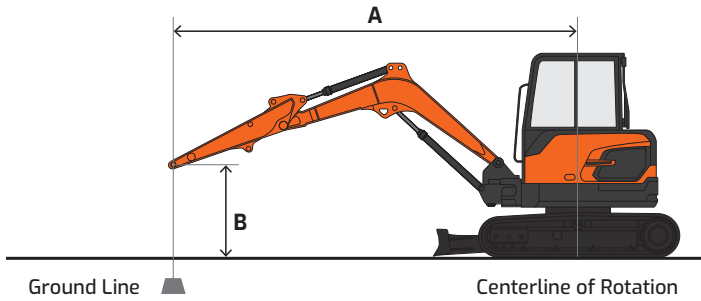

Standard & Optional Equipment

| Standard Base Package, US10

■ Standard • Optional

Engine

Emissions, T4 (EPA)	■
Direct fuel injected	■
Fuel filter with water separator	■
Coolant recovery tank	■
Dual element dry-type air filter	■
Electronic engine control	■
Auto preheat cold start assist	■
Auto idle	■
Overheat & low oil pressure engine protection	■

Hydraulic

Variable axial piston main pump	■
Load sensing pump control	■
Pilot-operated control valves	■
Pilot gear pump (tandem)	■
Axial piston swing motor	■
Spring-applied hydraulic release brake	■
Axial piston travel motor (high/low, auto)	■
Auxiliary hydraulics, two-way	■
Adjustable auxiliary flow	■

Electrical

Alternator – 12 V, 90 amp	■
12 V battery, 725 CCA @ 0° F (-18° C)	■
Light: cabin (1), boom (1)	■
Additional lighting	•
Rotating beacon	•
Hour meter	■
Laptop service port	■
Self-diagnostics system	■

Cabin

Steel, all-weather & sound suppressed	■
ROPS/TOPS	■
Front window with wiper/washer	■
Tinted safety glass	■
Skylight	■
Pull-up type front window	■
Lockable doors	■
Seat	■
- 2" (51 mm) seat belt	■
- Adjustable height & recline	■
Adjustable armrests	■
Air conditioner with heater	■
Instrumentation panel, digital	■
Instrumentation panel, analog	•
AM/FM stereo & Bluetooth®	■
Speakers (2)	■
Power socket, 12 V	■
Interior light	■
Storage for operator's manuals	■

Controls

Joystick controls	■
- Two hydraulic joysticks control boom, arm, bucket & slew functions	■
- Thumb buttons control auxiliary hydraulics & boom swing	■
Blade control lever	■
- Thumb button controls travel speed low/high	■
Pattern control change valve (SAE, ISO)	■
Engine speed control dial	■
Travel pedals with hand levers	■
Switches, console-mounted	■
- Starter switch (key)	■
- Heater/AC control panel	■
- Boom swing switch	■
- Rotating beacon (if equipped)	■
- 12 V power socket & USB charger	■
- Keypad buttons	■
- Overload warning	■
- Travel/swing alarm	■
- Light	■
- Work lights	■
- Wiper & washer	■
- Auto idle	■
Emergency stop switch	■

Display Monitor & Warnings

Buzzer	■
- Engine oil pressure	■
- Coolant temperature	■
Touch screen display monitor	■
- Digital clock	■
- Menu select button	■
- Back button	■
- Fuel gauge	■
- Engine coolant temperature	■
- Hydraulic oil temperature	■
- Mode	■
- Tachometer	■
- Operating mode/flow setting selector	■
Indicator lights	■
- Air filter restriction indicator	■
- Engine check warning light	■
- Hydraulic oil warning	■
- Fuel warning	■
- Auto idle indicator	■
- Auxiliary flow mode indicator	■
- Engine oil pressure light with audible alarm	■
- Pre-heat (cold start assist) indicator	■
- Two-speed travel indicator light	■
Travel alarm	■

Undercarriage

Track rollers, upper (1 each side)	■
Track rollers, lower (4 each side)	■
Rubber tracks – 300 mm	■
Shoes, steel grouser – 400 mm (39 each side)	•

Other

Centralized lubrication	■
- Swing pinion	■
- Swing bearing	■
Dozer blade	■
Manuals	■
- Operation	■
- AEM Safety Manual	■
- Parts	■
- Service	■
Vandalism protection	■
- Lockable panels	■
- Lockable fluid fill points	■
DEVELON Fleet Management 3-year subscription	■

Certain specification(s) are based on engineering calculations and are not actual measurements. Specification(s) are provided for comparison purposes only and are subject to change without notice. Specification(s) for your individual DEVELON equipment will vary based on normal variations in design, manufacturing, operating conditions, and other factors. Pictures of DEVELON units may show other than standard equipment.

Powered by Innovation

DEVELON

A brand of HD Hyundai Infracore.

na.develon-ce.com/dx55r-7

DX55R-7 Mini Excavator Spec Sheet
Printed in the U.S.A.
23906_002_D082923

©2023 HD Hyundai Infracore. All rights reserved.